

SEALEY

PROFESSIONAL GAS/NO-GAS MIG WELDER WITH EURO TORCH

MODEL NO'S:

**MIGHTYMIG170.V3, MIGHTYMIG190.V3,
MIGHTYMIG210.V3**

Thank you for purchasing a Sealey product. Manufactured to a high standard, this product will, if used according to these instructions, and properly maintained, give you years of trouble free performance.

IMPORTANT: PLEASE READ THESE INSTRUCTIONS CAREFULLY. NOTE THE SAFE OPERATIONAL REQUIREMENTS, WARNINGS & CAUTIONS. USE THE PRODUCT CORRECTLY AND WITH CARE FOR THE PURPOSE FOR WHICH IT IS INTENDED. FAILURE TO DO SO MAY CAUSE DAMAGE AND/OR PERSONAL INJURY AND WILL INVALIDATE THE WARRANTY. KEEP THESE INSTRUCTIONS SAFE FOR FUTURE USE.



Refer to instruction manual



Wear a welding mask



Wear protective gloves



Warning!
Electricity
Shock hazard



Warning!
Keep away from rain



Caution required



Arc rays can burn eyes and injure skin



Electric shock from welding electrodes can kill



Breathing welding fumes can be hazardous to your health



Electromagnetic fields can cause pacemaker malfunction



Welding sparks can cause explosions or fire

1. SAFETY

1.1. ELECTRICAL SAFETY

- ❑ **WARNING!** It is the responsibility of the owner and the operator to read, understand and comply with the following:
- ✓ You must check all electrical products, before use, to ensure that they are safe. You must inspect power cables, plugs, sockets and any other connectors for wear or damage. You must ensure that the risk of electric shock is minimised by the installation of appropriate safety devices. A Residual Current Circuit Breaker (RCCB) should be incorporated in the main distribution board. We also recommend that a Residual Current Device (RCD) is used. It is particularly important to use an RCD with portable products that are plugged into a supply which is not protected by an RCCB. If in any doubt consult a qualified electrician. You may obtain a Residual Current Device by contacting your Sealey stockist. You must also read and understand the following instructions concerning electrical safety.
- 1.1.1. The **Electricity at Work Act 1989** requires that all portable electrical appliances, if used on business premises, are tested by a qualified electrician, using a Portable Appliance Tester (PAT), at least once a year.
- 1.1.2. The **Health & Safety at Work Act 1974** makes owners of electrical appliances responsible for the safe condition of those appliances and the safety of the appliance operators. **If in any doubt about electrical safety, contact a qualified electrician.**
- 1.1.3. Ensure that the insulation on all cables and on the appliance is safe before connecting it to the power supply. See 1.1.1. and 1.1.2. and use a Portable Appliance Tester.
- 1.1.4. Ensure that cables are always protected against short circuit and overload.
- 1.1.5. Regularly inspect power supply cables and plugs for wear or damage and check all connections to ensure that none are loose.
Important: Ensure that the voltage marked on the appliance matches the power supply to be used and that the supply is correctly fused.
 - ✗ **DO NOT** pull or carry the appliance by the power cable.
 - ✗ **DO NOT** pull the plug from the socket by the cable.
 - ✗ **DO NOT** use worn or damaged cables, plugs or connectors. Immediately have any faulty item repaired or replaced by a qualified electrician.
- 1.1.6. MIGHTYMIG170.V3, MIGHTYMIG190.V3, MIGHTYMIG210.V3 are single phase machines and must be run from a minimum 16amp supply.
To achieve maximum output these models will require a 30Amp fused supply. We recommend you discuss the installation of an industrial round pin plug and socket with your electrician.
Fit a plug according to the following instructions (UK only).
 - a) **Connect the GREEN/YELLOW earth wire to the earth terminal 'E'.**
 - b) **Connect the BROWN live wire to the live terminal 'L'.**
 - c) **Connect the BLUE neutral wire to the neutral terminal 'N'.**
 - d) **After wiring, check that there are no bare wires, that all wires have been correctly connected, that the cable outer insulation extends beyond the cable restraint and that the restraint is tight.**
- 1.1.7. When a cable extension reel is used it should be fully unwound before connection. A cable reel with an RCD fitted is recommended since any product which is plugged into the cable reel will be protected. The cross-section of the cable on the cable reel must be suitable for the unit and never lower than the cross-section of the mains cable supplied with the unit.
- 1.2. **GENERAL SAFETY**
 - ▲ **DANGER! Unplug the welder from the mains power supply before performing maintenance or service.**
 - ✓ Keep the welder and cables in good condition. Take immediate action to repair or replace damaged parts.
 - ✓ *Use genuine parts and accessories only. Unapproved parts may be dangerous and will invalidate the warranty.*
 - ✓ Use an air hose to regularly blow out any dirt from the liner and keep the welder clean for best and safest performance.
 - ✓ Check and spray the gas cup and contact tip regularly with anti-spatter spray which is available from your Sealey stockist.
 - ✓ Locate the welder in a suitable work area. Ensure that the area has adequate ventilation as welding fumes are harmful.
 - ✓ Keep work area clean, tidy and free from unrelated materials. Also ensure that the work area has adequate lighting and that a fire extinguisher is at hand.

- ❑ **WARNING! Use welding head shield to protect eyes and avoid exposing skin to ultraviolet rays given off by electric arc. Wear safety welding gauntlets.**
 - ✓ Remove ill fitting clothing, remove ties, watches, rings and other loose jewellery and contain long hair.
 - ✓ Ensure that the workpiece is correctly secured before operating the welder.
 - ✓ Avoid unintentional contact with workpiece. Accidental or uncontrolled use of the torch may be dangerous and will wear the nozzle.
 - ✓ Keep unauthorised persons away from the work area. Any persons working within the area must wear protective head shield and gloves.
 - ✓ Operators must receive adequate training before using the welder.
 - ✓ Stand correctly, keeping a good footing and balance, and ensure that the floor is not slippery. Wear non-slip shoes.
 - ✓ Turn voltage switch to OFF when not in use.
 - ✗ **DO NOT** operate the welder if it or its cables are damaged and **DO NOT** attempt to fit any unapproved torch or other parts to the welder unit.
 - ✗ **DO NOT** get welder wet or use in damp or wet locations or areas where there is condensation.
 - ▲ **DANGER! DO NOT weld near inflammable materials, solids, liquids, or gases, and DO NOT weld containers or pipes which have held flammable materials or gases, liquids or solids. Avoid operating on materials cleaned with chlorinated solvents or near such solvents.**
 - ✗ **DO NOT** stand welder on a metal workbench, car bodywork or similar object.
 - ✗ **DO NOT** touch any live metal parts of the torch or electrode while the machine is switched on.
 - ✗ **DO NOT** pull the welder by the cable or the torch and **DO NOT** bend or strain cables. Protect cables from sharp or abrasive items and **DO NOT** stand on them. Protect from heat. Long lengths of slack must be gathered and neatly coiled. **DO NOT** place cables where they could endanger other people.
 - ✗ **DO NOT** touch the torch or workpiece immediately after welding as they will be very hot. Allow to cool.
 - ✗ **DO NOT** operate welder while under the influence of drugs, alcohol or intoxicating medication, or if tired.
 - ✓ When not in use store the welder in a safe, dry, childproof area.
- 1.3. GAS SAFETY**
- ✓ Store gas cylinders in a vertical position only and ensure that the storage area is correctly secured.
 - ✗ **DO NOT** store gas cylinders in areas where temperature exceeds 50°C. **DO NOT** use direct heat on a cylinder. Always keep gas cylinders cool.
 - ✗ **DO NOT** attempt to repair or modify any part of a gas cylinder or valve and **DO NOT** puncture or damage a cylinder.
 - ✗ **DO NOT** obscure or remove any official cylinder labels. Always check the gas identity before use. Avoid getting gas cylinders oily or greasy.
 - ✗ **DO NOT** lift a cylinder by the cap, guard or valve. Always keep caps and guards in place and close valve when not in use.

2. INTRODUCTION

Heavy-duty high output transformer and forced air cooling to maximize duty cycle performance. Supplied with high quality cool running Ergo 15.2 Euro torch, 2m earth cable, 1.4m gas hose, twin gauged gas regulator and 0.6 & 0.8mm contact tips. Set-up in the gas welding mode but can also easily be switched to gasless. Can be used with large, industrial CO2 gas bottles.

IMPORTANT: These instructions contain information you require to prepare your machine for welding, together with a maintenance and trouble shooting section. If you have no previous experience the instructions are not intended to show you how to become a welder. Should you have no experience, we recommend that you seek training from an expert source. MIG welding is relatively easy to perform, but does require a steady hand and time practising under supervision with scrap metal as it is only with continued practice that you will achieve the desired results.

3. SPECIFICATION

Model no.	MIGHTYMIG170.V3	MIGHTYMIG190.V3	MIGHTYMIG210.V3
Welding current	40-170A	40-190A	45-210A
Wire capacity	5kg	5-15kg	5-15kg
Duty cycle	100% @ 55A, 60% @ 70A, 15% @ 140A	100% @ 70A, 60% @ 90A, 15% @ 180A	100% @ 80A, 60% @ 105A, 15% @ 210A
Cooling system	Forced air	Forced air	Forced air
Gas type	CO2, Argon, CO2/Argon mix	CO2, Argon, CO2/Argon mix	CO2, Argon, CO2/Argon mix
Torch	3m Euro Non - Live - Ergo 15.2	3m Euro Non - Live - Ergo 15.2	3m Euro Non - Live - Ergo 15.2
Supply	230V - 16A (To achieve maximum power a 32A supply may be required).	230V - 16A (To achieve maximum power a 32A supply may be required).	230V - 16A (To achieve maximum power a 32A supply may be required).
Absorbed power	5.4kW	7.2kW	9kW
Case size	Large	Large	Large
Gasless: Flux cored wire	TG100/4	TG100/4	TG100/4
Consumables: Replacement tips 1mm (pack of 5):		TG100/2	TG100/2

4. ASSEMBLY

4.1. ASSEMBLING THE WHEELS: (Refer to fig.1) The wheels are more easily assembled with the welder placed upside down on a smooth non-abrasive surface. The welder should be turned over by two people as it is very heavy.

4.1.1. Bolt the two castors (1) to the front end of the base (2) using the bolts provided.

4.1.2. Take the solid axle (3) and slide a wheel (4) over one end followed by a washer (5). Insert a split pin (6) through the hole in one end of the axle as shown below and bend it over.

4.1.3. Take an axle retaining bracket (7) and insert it into the slots in the base (2).

4.1.4. Hold the bracket in place and slide the axle assembly through both parts of the bracket. Insert the second axle retaining bracket (7) through the base and continue to slide the axle across so that it passes through the second bracket and holds the wheel (4) up against the side of the base. Slide the second wheel (8) onto the free end of the axle followed by a washer (9). Retain the entire axle assembly by passing a split pin (10) through the free end of the axle and bend it over to retain the whole axle assembly.

4.1.5. With the assistance of another person turn the welder the right way up onto its wheels.

4.2. ASSEMBLING THE HANDLE: (Refer to fig.2)

4.2.1. On the front of the welder there are two pairs of threaded inserts, one pair in the top left corner and one pair in the top right hand corner.

4.2.2. Attach the left hand handle mounting (1) to the front of the welder using two of the 25mm round headed bolts provided. **DO NOT** fully tighten yet.

4.2.3. Slide the handle tube (2) into the socket in the mounting and push fully home.

4.2.4. Slide the socket on the right hand handle mounting (3) over the free end of the handle tube and rotate the mounting downwards until it is resting on the front of the welder. Using two of the 25mm round headed bolts provided to fix the right hand mounting in place.

4.2.5. Now fully tighten all four fixings.

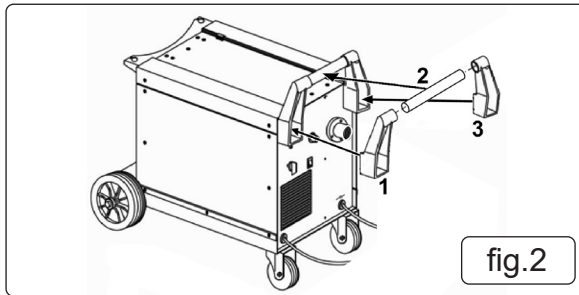

4.3. ASSEMBLING THE EARTH CLAMP (Refer to fig.3)

4.3.1. Feed the eyelet on the end of the earth lead through the hole in the clamp arm as shown in fig.3A.

4.3.2. Drop the eyelet over the terminal and firmly fix with the bolt provided as shown in fig.3B.

4.4. INSTALLING THE GAS CYLINDER

4.4.1. The welder is designed to accommodate small or medium sized gas cylinders up to a maximum height of 1000mm. Contact your local Gas dealer for supply.

4.4.2. Place the gas cylinder onto the rear platform of the welder. Drop one end of the fixing chain into one side of the retaining bracket. Draw the chain around the cylinder and place it into the slot on the other side of the bracket leaving as little slack in the chain as possible.

4.5. ATTACHING THE REGULATOR

4.5.1. Whichever gas you are using it is advisable to 'crack' the cylinder valve before attaching the regulator. This means opening and closing the valve very quickly in order to blow away any dust and dirt that may have accumulated in the gas outlet. Stand to one side whilst doing this.

4.6. CO² GAS

- WARNING!** Ensure that the threads on the gas bottle are undamaged and free of oil and grease before attaching the regulator. (Oil or grease in the presence of high pressure gases can be explosive.) Ensure that the regulator has an undamaged gasket fitted. The regulator will screw directly to the threads on the gas bottle. Tighten with a spanner.

4.7. ARGON GAS OR ARGON MIXTURES

4.7.1. Cylinders containing Argon gas and Argon mixtures have a female thread and will require the use of a Bull Nose Adaptor to attach the regulator to the cylinder as indicated in fig.4. Ensure that the threads on the gas bottle are undamaged and free of oil and grease before attaching the regulator. (Oil or grease in the presence of high pressure gases is explosive.) Fit the Bull Nose Adaptor to the cylinder first and tighten with a spanner. Ensure that the regulator has an undamaged gasket before fitting onto the Bull Nose Adaptor. Tighten with a spanner.

4.7.2. Slide a jubilee clip over each end of the gas hose supplied. Push one end of the hose onto the regulator outlet and the other end over the gas inlet spigot on the back of the welder. Tighten the clips to ensure a good seal.

4.7.3. Close the regulator valve by turning it anticlockwise before opening the cylinder valve. Stand to one side when opening the cylinder valve.

4.7.4. Set the regulator flow rate to 5-8 litres/min depending on the material to be welded, and whether there are draughts which are strong enough to disturb the gas flow.

4.8. CONNECT THE TORCH CABLE TO THE WELDER

4.8.1. Align the pins on the Euro connector with the socket on the welder front panel as shown in fig.5. Push the connector into the socket and rotate the locking ring (A) clockwise so that it draws the plug into the socket as shown in fig.6.

Note: Damage to torches and cables is not covered by warranty.

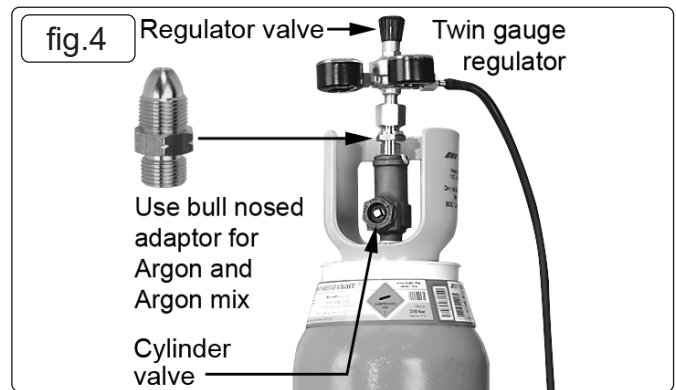
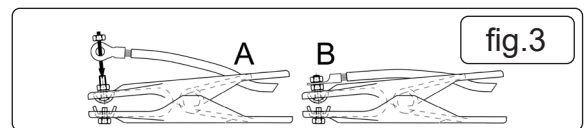
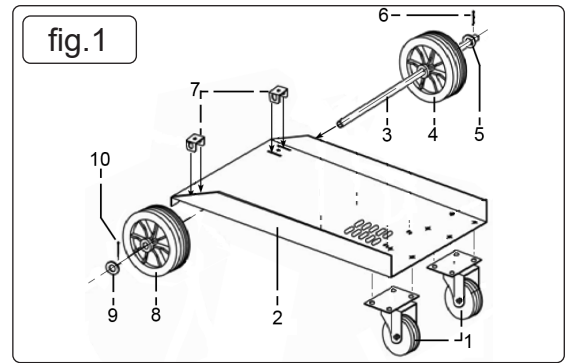

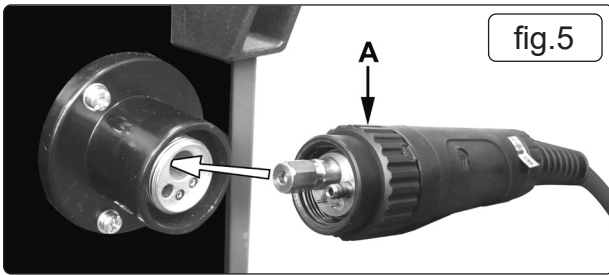

4.9. FITTING A 15KG REEL OF WIRE

4.9.1. MIGHTYMIG models 190 & 210 will accept either a 5kg or a 15kg reel of wire. MIGHTYMIG170 will only accept a 5kg reel of wire. Ensure that the wire diameter used, is matched by the correct groove size in the drive wheel and the correct tip size on the torch as well as the correct torch liner. Failure to do this could cause the wire to slip and/or bind.

4.10. Unscrew the locking knob from the end of the spool holder (see fig.7) and remove the spacer. Slide the reel of wire onto the spool holder and ensure that the clutch pin at the back of the spool holder engages into the guide hole in the wire reel moulding. This will prevent the wire reel from free-wheeling on the spool holder. When using a 5kg reel, slide the spacer onto the spool holder before re-fixing the locking knob. Ensure that the wire is coming off the top of the reel in the direction of the wire drive unit as shown in fig.8 which shows a 15kg reel of wire in place on the spool holder.

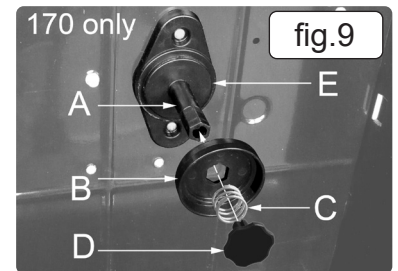
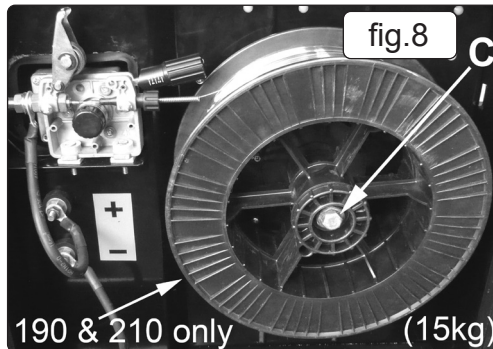
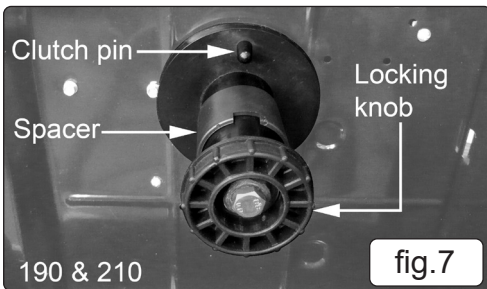

4.11. FITTING A 5KG REEL OF WIRE

4.11.1. MIGHTYMIG 170 will only accept a 5kg reel of wire. Ensure that the wire diameter used, is matched by the correct groove size in the drive wheel and the correct tip size on the torch as well as the correct torch liner. Failure to do this could cause the wire to slip and/or bind.

4.11.2. Remove the retaining knob (D) from the end of the spindle (A) by turning the knob 90° anticlockwise and pulling it outwards (see fig.9).

4.11.3. Remove the spring (C) and the retaining disc (B) from the end of the spindle also. Slide the reel of wire over the spindle and hold it against the back plate so that the hole in the reel rests on the flange (E). Ensure that the wire is coming off the top of the reel in the direction of the wire drive unit as shown in fig.10.

4.11.4. Retain hand pressure on the reel to keep it on the flange and slide the retaining disc (B) over the end of the spindle and into the hole in the reel. Note that the disc (B) has a hexagonal hole in it which fits onto the hexagonal portion of the spindle. Keep the disc under hand pressure to retain the reel. Place the spring (C) over the spigot of the retaining knob (D). Match the indented end of the spigot to the hole in the end of the spindle. Push the knob spigot into the end of the spindle, against spring pressure and turn it through 90° to lock it in place.

4.12. FEED WIRE THROUGH TO TORCH

4.12.1. Open the wire feed mechanism by pushing the locking/wire tension knob (1) down to the right allowing the pressure roller carrier (2) to spring up revealing the feed roller as shown in fig.11. Ensure that the required feed groove (0.6 or 0.8) is in line with the wire path. See Section 4.17 on how to reverse or change the roller.

4.12.2. Release the wire from the reel and cut off any bent portion ensuring that there are no burrs left on the end of the wire. Keep the wire under tension at all times to prevent it uncoiling.

4.12.3. Straighten about 40-50mm of wire and gently push it through the flexible metal sheathed cable, fig.11 (3) and through the 6 or 8mm feed roller groove and on into the torch cable liner.

4.12.4. Push down the pressure roller carrier onto the wire feed roller and hold it down. Lift up the locking/wire tension knob so that it enters the slot in the pressure roller carrier and snaps into the indent in its top surface. See fig.13. Rotate the tension knob to a medium setting i.e. between 2 and 3.

4.12.5. Remove gas cup (fig.12-2) and contact tip (1) from end of torch as follows:

- Take torch in left hand with the torch tip facing to the right.
- Grasp gas cup firmly in your right hand.
- Turn gas cup clockwise only and pull it off end of torch tip.

❑ **WARNING! DO NOT** turn gas cup anti-clockwise, as this will damage the internal spring.

- Unscrew copper contact tip (right hand thread) to remove.

Check welder is switched off "0", and that the earth clamp is away from the torch tip. Connect the welder to the mains power supply and set the voltage switch to one.

Set the wire speed knob to position 5 or 6. Keep the torch cable as straight as possible and press the torch switch. The wire will feed through the torch.

When the wire has fed through, switch welder off, unplug from mains.

- Take torch in left hand, slide the contact tip over the wire and screw back into place.
- Grasp gas cup in right hand, push onto torch head and turn clockwise only.

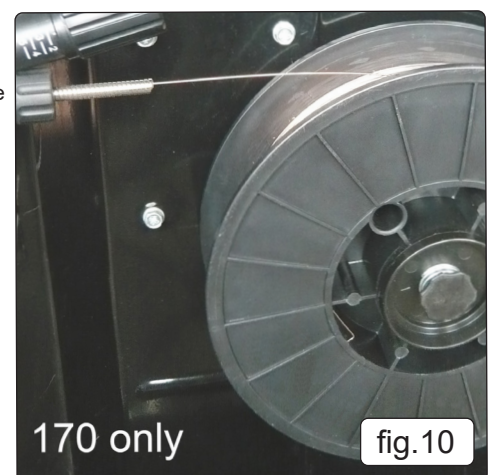

DO NOT turn gas cup anti-clockwise, as this will damage the internal spring.

c) Cut wire so that it is just protruding from the cup.

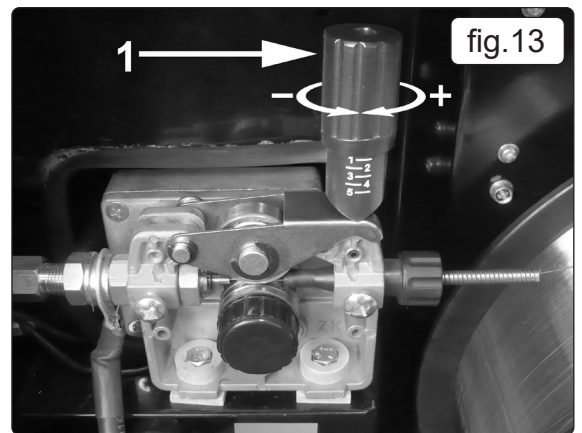
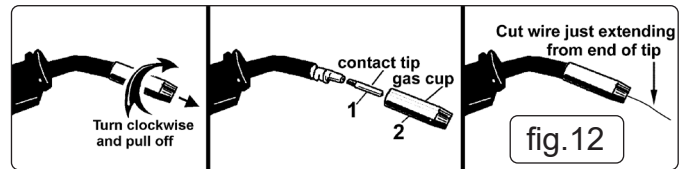
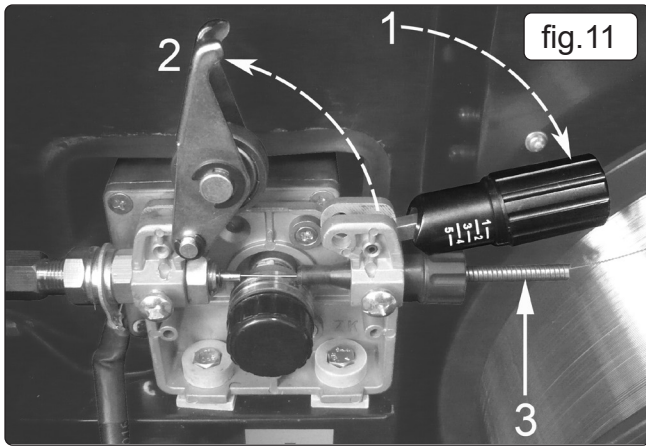

4.13. SETTING WIRE TENSION.

4.13.1. Adjust the wire tension by rotating the wire tension knob. Turn clockwise to increase the tension and anticlockwise to decrease the tension. See (1) in fig.13.

IMPORTANT: Too little or too much tension will cause problematic wire feed and result in poor welding.

4.13.2. Tension between rollers is checked by slowing down the wire between gloved fingers. If top feed roller skids the tension is correct. Use as low a tension as possible, too high a tension will disfigure wire and result in a blown fuse.

4.14. CLUTCH ADJUSTMENT.

NOTE: It is essential that the clutch is adjusted correctly.

4.14.1. Once the wire is fed through the torch, switch on the machine and set the wire speed to maximum.

4.14.2. Depress torch switch and release quickly. If the spool overruns it indicates that the clutch is too loose.

4.14.3. Tighten the clutch nut located in the centre of the wire spool holder with a spanner (fig.8-C) and test the machine as above until the wire stops over running.

NOTE: DO NOT over tighten the clutch as this will cause wire feed problems and strain the motor. (MIGHTYTMIG170 is preset and has no direct clutch adjustment.)

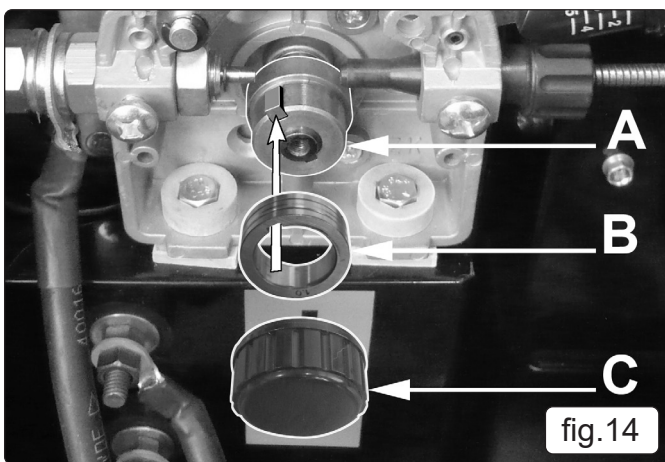

4.15. TURNING/CHANGING THE DRIVE ROLLER (See fig.14)

4.15.1. Ensure that the wire diameter used, is matched by the correct groove size in the drive wheel and the correct tip size on the torch as well as the correct torch liner. Failure to do this could cause the wire to slip and/or bind.

4.15.2. Referring to fig. 11, open the wire feed mechanism by pushing the locking/wire tension knob (1) down to the right allowing the pressure roller carrier (2) to spring up revealing the feed roller.

4.15.3. Referring to fig.14, loosen and unscrew the black feed roller retaining knob (C) and put to one side.

4.15.4. The roller carrier (A) is keyed to the main drive shaft and the drive roller (B) is keyed to the carrier. Place a finger onto the end of the drive shaft to prevent the carrier moving and slide the drive roller off the carrier with your other hand.

4.15.5. The size of each wire feed groove is printed on the edge of the roller on the same side as the groove.

4.15.6. Turn the roller over to use the other groove or use a roller with different sized grooves as required. The groove to be used should be positioned furthest away from you to be in line with the drive path.

4.15.7. Check that the key in the carrier (A) is properly seated in its slot. Ensure that the slot on the inside face of the drive roller (B) is aligned with the key and slide the roller back onto the carrier.

4.15.8. Screw the black roller retaining knob (C) back on to the end of the drive shaft and tighten.

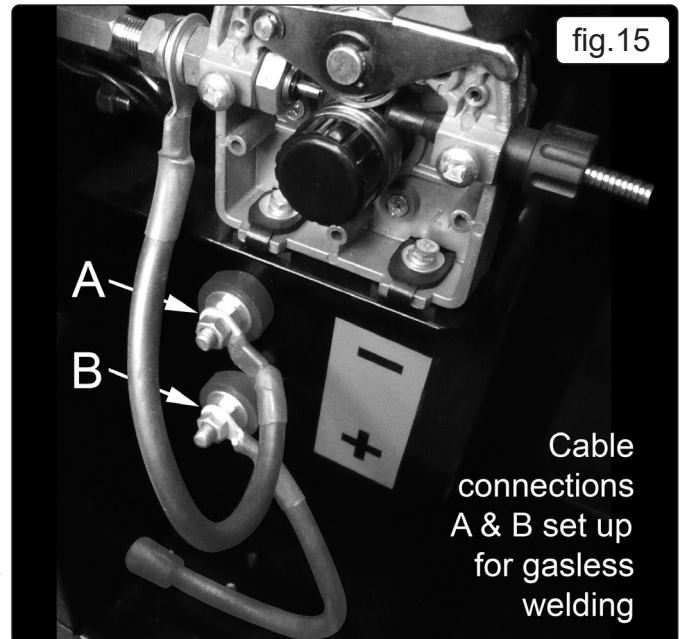

Cable connections A & B set up for gasless welding

5. MIG/MAG WELDING

- 5.1. A spool of welding wire is positioned on the welder's spool holder and automatically fed through an insulated liner in the torch to the tip. The torch assembly consists of a switch, liner, gas hose, and control cable. The switch activates the wire feed roller and the gas flow. Conversely, releasing the switch stops the wire feed and gas flow. The weld current is transferred to the electrode (the wire) from the contact tip at the end of the torch. A gas cup fits over the contact tip to direct the gas flow towards the weld ensuring that the arc welding process is shielded from oxidising air contaminants. The shielding gas also assists heating of the weld materials. (The welder can also be used in gasless mode using flux cored wire). The torch is connected to the positive side of a DC rectifier, and the negative clamp is attached to the workpiece.

IMPORTANT: Should you have no welding experience, we recommend you seek training from an expert source to ensure your personal health & safety. Good Mig welding may be achieved only with continued, supervised practice.

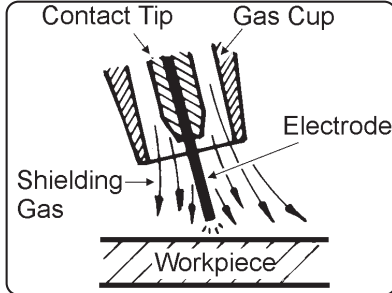

SETTINGS SHOWN AS GUIDE ONLY						
Wire 0.6mm Steel Argon / CO ₂ Mix						
Voltage step	1	2	3	4	5	6
Wire speed	5	6	7	8	9	10

5.3. PREPARATION FOR WELDING

IMPORTANT: BEFORE YOU COMMENCE, MAKE SURE THE MACHINE IS SWITCHED OFF AT THE MAINS. IF WELDING A CAR, DISCONNECT THE BATTERY OR FIT AN ELECTRONIC CIRCUIT PROTECTOR. WE STRONGLY RECOMMEND THE USE OF SEALEY "PROSAF/12V OR 24V IN ORDER TO PROTECT SOPHISTICATED ELECTRONICS. ENSURE YOU HAVE READ & UNDERSTOOD THE ELECTRICAL SAFETY INSTRUCTIONS IN CHAPTER 1.

5.3.1. Connecting the Earth Lead

To ensure a complete circuit, the earth lead must be securely attached to the work piece that is to be welded.

- Best connection is obtained by grinding clean the point of contact on the workpiece before connecting the earth clamp.
- The weld area must also be free of paint, rust, grease, etc.
- When welding a vehicle, be sure the vehicle battery is disconnected or fit an Electronic Circuit Protector available from your Sealey stockist, see 5.3 above.

5.3.2. Power Output switch

Set the switch to position 1 or 2 for welding up to 2mm thickness. Use settings 3,4,5,6. for thicker welds.

5.3.3. Setting the welder controls

In principle, the lower the amperage required, the slower the wire speed. See setting chart for voltage and corresponding wire speeds. Note: these settings are only a guide and will vary according to the operators experience.

5.3.4. Welding mild steel

To weld mild steel you can use CO₂ gas for most tasks where spatter and the high build up of weld do not pose a problem. Welding with a long arc reduces penetration and widens the arc. This in turn results in more spatter. A long welding arc can be appropriate for welding butt joints in thin materials. Welding with a short arc, at the same weld settings, results in greater penetration and a narrower weld and reduces the amount of spatter. To achieve a consistent spatter free and flat weld, you must use an Argon/CO₂ mixture.

5.3.5. To weld aluminium use:

- Argon gas,
- 0.8mm Contact Tip (MIG927),
- 0.8mm Aluminium Wire, (MIG/2KAL08).

5.3.6. Overload Protection.





Thermostatic overload protection is provided. When an overload has occurred, leave the unit to cool. The thermostat will automatically reset the unit when the temperature has returned within limits.



6. RATINGS PLATE

On the front panel of the welder is the ratings plate, giving the following data:

- 1 - The BS/EU standard relating to the safety and construction of arc welding and associated equipment.
- 2 - Single phase transformer.
- 3 - Symbol indicates welding with a continuous flow of welding wire.
- 4 - Symbol for Single-phase AC supply.
- 5 - Rating of internal protection provided by casing.
- 6 - Output U_0 Rated minimum and maximum no load voltage.
 I_2, U_2 Current and corresponding voltage.
 X Welding ratio based on a 10 minute cycle.
 20% indicates 2 minutes welding and 8 minutes rest,
 100% would indicate continuous welding.
- 7 - Mains Supply
 U_1 Rated supply voltage and frequency.
 I_{1max} Maximum current.
 I_{1eff} Maximum effective current.
- 8 - Welding current range.
- 9 - Serial Number. Specifically identifies each welder.

MIGHTYMIG 190		No. 0867001		⑨	
②		EN 60974-1: 2005		①	
③		40A - 190A			⑧
		$U_0=25-46V$	I_2 180A	⑥	
			U_2 23V		
			15% 60% 100%		
			90A 70A		
④		$U_1=230V$	$I_{1max}=31.5A$	⑦	
⑤	IP21				
			$I_{1eff}=13A$		
			1 ~ 50Hz		

7. MAINTENANCE

7.1. WIRE FEED UNIT

Check the wire feed unit at regular intervals. The feed roller wire guide plays an important part in obtaining consistent results. Poor wire feed affects welding. Clean the rollers weekly, especially the feed roller groove, removing all dust deposits.

7.2. TORCH

Protect the torch cable assembly from mechanical wear. Clean the liner from the machine forwards by using compressed air. If the liner is clogged it must be replaced.

7.3. CHANGING FEED ROLLER (See Section 4.15)

7.4. CONTACT TIP

The contact tip is a consumable item and must be replaced when the hole becomes enlarged or oval. The contact tip MUST be kept free from spatter to ensure an unimpeded flow of gas. Refer to fig.12 and section 4.12.5 for removal and replacement.

7.5. GAS CUP

The gas cup must also be kept clean and free from spatter. Build up of spatter inside the gas cup can cause a short circuit at the contact tip which will result in either the fuse blowing on the printed circuit card, or expensive machine repairs. To keep the contact tip free from spatter, we recommend the use of Sealey anti-spatter spray (MIG/722308) available from your Sealey stockist. Refer to fig.12 and section 4.12.5 for removal and replacement.

7.6. REPLACING THE LINER

Wind the wire back on to the spool and secure it. Unscrew the torch from the machine and undo the brass nut. The liner should now be visible. Pull it out and replace with a new one.

8. TROUBLESHOOTING

PROBLEM	POSSIBLE CAUSE	REMEDY
1. Power source stops	Overheating protection activated due to overload	Protection automatically resets when transformer has cooled (about 15 min)
2. No weld current	Rectifier blown	Replace rectifier
3. No weld current	Bad connection between clamp & workpiece	Clean or grind contact surface and weld area
	Break in earth lead	Repair or replace earth lead
	Break in torch lead	Repair or replace torch
	Gear damaged or worn	Replace gears. (Contact service agent)
	Motor defective	Replace motor (Contact service agent)
5. Wire does not feed, feed roller rotates	Pressure roller improperly adjusted	Adjust tension
	Dirt, copper, dust, etc, has collected in torch liner	Clean the liner from the machine forward. Use compressed air. If too much dirt, replace the liner
	Gas cup (Nozzle) or tip defective	Replace gas cup (nozzle) and/or tip. (Section 4.12.5)
	Deformed wire	Check roller tension and adjust it if necessary (Section 4.13)
6. Wire feeds unevenly	Dirt, etc, in liner	Clean the liner from the machine forward. Use compressed air
	Gas cup (Nozzle) or Tip defective	Replace gas cup (nozzle) and/or tip. (Section 4.12.5)
	Gas cup (Nozzle) spattered	Clean or replace gas cup (nozzle) (Section 4.12.5)
	Feed roller groove clogged	Clean feed roller. (Section 4.15)
	Feed roller groove deformed	Replace feed roller. (Section 4.15)
	Pressure roller tension improper	Adjust tension. (Section 4.13)
7. Unstable arc	Incorrect settings	Check settings. (Section 5)
	Impurities in weld area	Clean and/or grind workpiece. (Section 5.3.1)
	Worn or defective gas cup (nozzle)	Replace gas cup (nozzle). (Section 4.12.5)

8. Porous weld	No gas	Open gas cylinder, regulate gas flow
	Gas cup clogged	Clean or replace cup. (nozzle) (Section 4.12.5)
	Draft blowing away shielding gas	Screen off welding site or increase gas flow
	Rusty or dirty joints	Clean and/or grind workpiece
	Torch too far from or at wrong angle to work	The distance from gas cup to workpiece should be 8 to 10mm
	Gas leak	Check hoses, connections and torch assembly. (Section 3). Press the gas cup in correction position
	Faulty Electrovalve	Clean out or replace
9. Electrode sticking in gas cup (nozzle)	Worn or defective gas cup (nozzle)	Replace gas cup (nozzle). (Section 4.12.5)
	Electrode deformed	Check roller tension. (Section 4.13)
	Wire speed too slow	See recommendations for wire speed
10. Irregular weld head	Torch incorrectly held	Use correct torch angle
	Wire weaving in weld pool	Check roller tension and adjust as needed. (Section 3.10)
11. Weld bead too narrow and raised	Weld current too low	Increase power and wire speed. (Section 5)
	Weld speed too high	Move torch slower and weave a little more
12. Weld bead too wide	Weld current too high	Decrease power and wire speed. (Section 5)
	Weld speed too low	Move torch faster and weave less
	Arc too long	Bring torch closer to workpiece
13. Poor penetration	Weld current too low	Increase power and wire speed. (Section 5)
	Arc too long	Bring torch closer to workpiece
14. Excessive penetration	Weld current too high	Decrease power and wire speed. (Section 5)
	Weld speed too slow	Move torch faster
	Incorrect distance of torch to workpiece	Torch distance should be 8-10mm



WEEE REGULATIONS

Dispose of this product at the end of its working life in compliance with the EU Directive on Waste Electrical and Electronic Equipment (WEEE). When the product is no longer required, it must be disposed of in an environmentally protective way. Contact your local solid waste authority for recycling information.



ENVIRONMENT PROTECTION

Recycle unwanted materials instead of disposing of them as waste. All tools, accessories and packaging should be sorted, taken to a recycling centre and disposed of in a manner which is compatible with the environment. When the product becomes completely unserviceable and requires disposal, drain any fluids (if applicable) into approved containers and dispose of the product and fluids according to local regulations.

Note: It is our policy to continually improve products and as such we reserve the right to alter data, specifications and component parts without prior notice. Please note that other versions of this product are available. If you require documentation for alternative versions, please email or call our technical team on technical@sealey.co.uk or 01284 757505.

Important: No Liability is accepted for incorrect use of this product.

Warranty: Lifetime guarantee on Transformer - Comprises 1 year unconditional parts and labour on all parts, followed by a lifetime guarantee (parts and labour) conditional on registering your purchase with us online at www.sealey.co.uk.

Sealey Group, Kempson Way, Suffolk Business Park, Bury St Edmunds, Suffolk. IP32 7AR



01284 757500



01284 703534



sales@sealey.co.uk



www.sealey.co.uk